

Uniclass L4423	
CI/SfB (42)	

INTRAD RP200 Plate



INTRAD Buffer



INTRAD Plate



INTRAD D-Fender

INTRAD RP200 Plate

INTRAD RP200 plates are cost effective wall protection strips for protection to doors and walls. Ideal for use as a chair rail or general rubbing strip and as mid and low level kick plates on doors.

INTRAD RP200 provides economic, decorative protection. It is extremely versatile in application and is also quick and simple to install. INTRAD RP200 plate is the ideal solution where low cost protection against impact damage and wear is required.





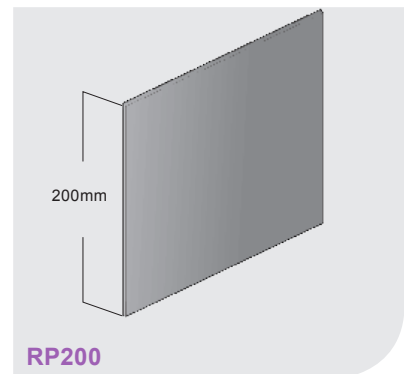
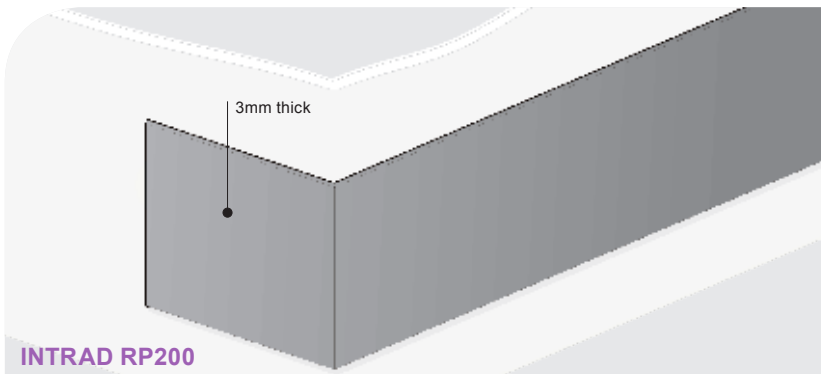

Also available is INTRAD RP125. Used as a low level partner to the standard INTRAD RP200 when used as a rubbing strip on walls and doors.



INTRAD RP200/RP125 Plate



Benefits:

-  Protects and preserves building interiors
-  Reduces maintenance costs
-  Fire resistant. Class O rated
-  Mid & Low Level protection
-  Chemical resistant
-  Suitable for wall & door protection

Other benefits include:

- Strong and resistant to impact
- Stylish, functional and decorative
- Highly cost effective
- Versatile in application
- Attractive embossed PVC-U finish
- Economic, quick and simple to install
- Standard length 3m

